

**ENGLISH**

**H93S**  
**ELECTRICAL CONTROL BOX**  
**INSTRUCTION MANUAL**

# 前 言

感谢您选用本公司的产品，该手册提供了此系统所需的操作指导说明。

**为了您更好地使用该产品，在使用之前请仔细阅读本手册。**

- 一、 由于产品的改进，本手册内容可能随时变更，恕不另行通知。
- 二、 您在使用中若有任何疑问或对我们的产品和服务有任何意见，请随时与我们售后服务部联系。

## PREFACE

Thank you for selecting our product. The introduction provides necessary knowledge and notes for using.

Please read safety introduction carefully and understand them before using.

The content of the introduction will be amended with the improvement of our product, the notice is not announced.

If you have any doubts or comments about our product and service, please contact after-sale service.







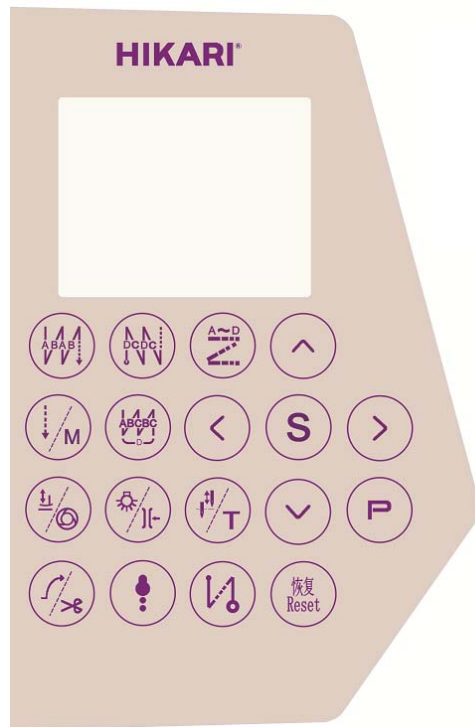

# Content

I. Operation panel.....	1
II. System function setting manu.....	3
1.Monitoring state: .....	3
2.Accounting state: Plus/Minus.....	3
3.Lower thread detect mode: .....	3
4.Aging mode: .....	4
5.Setting mode: .....	4
6.Ressting mode: .....	5
7.Copy original parameter and resetting original parameter: .....	5
8. Pattern design setting mode: .....	5
III. System parameter chart: .....	6
IV. Error code list: .....	10
V. Socket definition: .....	12

# 1.Operation panel





Function	Button	Description
Parameters setting key		1. Enter the level of different parameters (parameters are divided into 3) sewing set interface under short press P into the parameter interface, the level for the I parameter display parameter list. Long press the "P" button in the sewing setting interface to enter the "password input interface". After entering the correct maintenance password, press the "P" button to enter the "parameters interface". At this time, the parameters of level I and II in the parameter list are displayed
Identify key		1.identify key 2.for the belt clip line function model, the strength of long press this button to display the thread clamp, LCD display "[_7]"), press the key again to exit 3.Lock screen unlock key,press this key to unlock screen
Left or right key	 	1.At the free sewing interface, can adjust the speed by the left and right keys, the left button to reduce speed, the right button to increase speed. 2.At the free sewing interface,press S to enter 3333,setting the number of fixed stitches as the left and right keys. 3.When setting fixed long stitch, multisegments are showed to switch left and right. 4.When setting beauty stitch, multisegments are showed to switch left and right.
add-substract key	 	Under normal sewing interface 1. Adjust the stitch size 2. According to several numerical and subtract (S key seam free mode into the display number segment) 3. The parameter value plus or minus 4. Pattern edit value add and subtract
front Reinforcing-sewing		circulation: front Reinforcing-sewing / front double Reinforcing-sewing /front Four solid Reinforcing-sewing /turn off
back Reinforcing-sewing		circulation: Back Reinforcing-sewing / back double Reinforcing-sewing /back Four solid Reinforcing-sewing /turn off
Fixed seam pattern key		After this function is enabled, the front and rear fixed seams can be sewn according to the self-editing pattern

Sewing mode key		Short press:free sewing Long press to switch one-stitch sewing/multi-stitch sewing/Circulation 1. Able to set several sections of several stitches, each section can set a range of 0 ~ 99 stitches. 2. Able to set several sections of several stitches, each section can set a range of 0 ~ 99 stitches. 3. Able to set several sections of number sewing, each section can set the range of 0 ~ 99 stitches. each section of stitch length pattern can be knitting
Continuous Reinforcing-sewin		Circulation:w sewing Free seam circulation:w sewing Free seam
Presser foot function cycle key/ Trigger function key Settings		1.Foot presser function cycle: middle stop lifting foot/cutting line after lifting foot/middle stop cutting line after lifting foot/closing 2. Effective (on/off) in fixed-length seam mode (one-section seam, multi-section seam, multi-section seam self-knitting pattern) 3. W seam mode Open automatically 4.Presser foot function hot key:P+back Reinforcing-sewing
LED brightness adjustment/Thread clamp function		Short press:LED brightness adjustment, divided into 5 grades, 0-5 cycles Long press:Thread clamp function on and off. Electronic tension is enabled after open it
Stop needle selection key/ Trial teaching function		1:Short press:Up and down needle selection key(Default value:Down needle position) 2.P+T button:In fixed-length seam mode, try teaching mode 3.P+T button: in free seam mode, debug mode shortcut key (long press for more than 3 seconds)
Soft start/ Scissors function key		Short press: Press short: soft start on and off Long press:Scissors function on and off
Anti-nest function		Anti-nest function on and off.
Close stitch function		Close stitch function on and off.
Reset setting		Under standby interface, long press the Reset button for 1.5 seconds

## II. System Function Setting Description









### 1. System Info:

Operation panel default mode, press the button “ + ” key, enter the system monitoring

state. through the   key choose parameter at the project.

Code No.	Description	Unit
U1	speed of motor control	rpm
U2	Motor Current	0.01A
U3	Motor Voltage	V
U4	Pedal voltage	0.01V
U5	Mechanical Angle with	limit
U6	Motor initial Angle	limit
U7	Head type	JIA
U8	DSP version no.	V100
U9	DSP type	F73
U10	Step version no.	V1xx
U11	Step foot lift current	0.01A
VER	HMI Master chip version	v1xx
TYPE	HMI type	C104
AD1	Knee control sensor voltage	1mV

### 3. Lower thread detect mode:





Under the normal sewing mode, press " +  setting", enter "DX" accounting state. Press   key shows "JJ&DX" and "JP" interface, parameter on the screen shows current data, press  key exchange interface, press   key could change the current quantity, press "" key enter sewing mode.

Remark: 1、The quantity lower thread back to zero, long press  key 3 second under the system monitoring state.

2、Lower thread function is available should setting the parameter no. P30

3、Lower thread error: LBOB

### 4. Aging mode:

Under the normal sewing mode, press " + " assemble key, enter aging mode, press " + " key for operating, press again for stopping. Long press  key over 1 second could return back to normal mode from current state.

P94 parameter manual:

0: Time mode: Operate time P98, stop time P97。

1: Stitching mode: Stitching operate P98, stop time P97。

2: Easy mode: No need stop sewing, the other settle is same as 0。

3: Aging mode: Running 1S, stop 0.1S, speed 5000rpm。The other is same as easy mode。Total running time 15 minutes。

**Remark: The parameter data is setting 3 for aging mode of control box, damage head under this mode, no use this mode, our suggestion is change to mode 0.**



94	Auto test mode	0: Time mode (unit: S) 1: Stitching mode 2: Easy mode 3: Setting mode	0~10	3
96	Auto test max speed	Setting auto test max speed	200~5000(rpm)	3500
97	Auto test stop time	Setting auto test stop time	1~250(ms)	20
98	Auto test stitch setting	Auto test stitch setting	1~250(ms)	30

### 5. Setting mode:

Under the normal sewing mode, long press  key 3 second, enter setting mode, press  key could return back to normal mode from current mode.

1-DJ	Motor angle test
2-bJ	Step zero setting
3-PD	Pedal zero test
4-JD	Trimming operate test
5-CP-1/2	Main shaft encode signal test, solenoid signal test

#### 5.1 Motor sensor angle setting test mode:







Under normal sewing mode, long press  key 3 seconds, screen appear "1-dJ", press  key enter motor angle test interface, appear "dj", toward forward pedal one time (or press ), motor

will run several times, and then angle data will appear on the screen, it means motor sensor angle data.

Press  key could return back to normal mode from current mode.





**Remark: The function used for needle stop un-usual or check whether the parameter data of sensor angle is correct or not when high speed stitching.**

#### Step zero setting:

Under normal sewing mode, long press  key 3 seconds, screen appear "1-dJ", press  key exchange to "2-bJ", press  key enter machine zero position interface, appear "P-75—00", press  key exchange P-75/P6/P7/P8 circle, press  key enter current parameter, press  key adjust data, press  key for confirm and exit current interface.





Press  key could return back to normal mode from current mode.



#### 5.2 Pedal zero position setting mode:

Under normal sewing mode, long press  key 3 seconds, screen appear "1-dJ", press  key exchange to "3-Pd", press  key enter pedal zero position interface, the screen appear "pdL", now the system will checking by it self, waiting 3 seconds, the screen appear "PASS", if self-checking is fault, the screen will appear error code no. Press  key could return back to normal mode from current mode.



**Remark: The function is used for pedal running error, adjust the parameter data through software program.**

#### 6. Resetting mode:







Under normal sewing mode, long press  key enter parameter interface, appear "0" when enter parameter no. "P79", press  key and adjust to "8", appear "yes" after press "S" key **【press  key could adjust to "no"】**, and then press  key for confirm.

Hotkey for resetting: Under normal sewing mode, long press  key over 1.5 seconds, appear "yes" **【press  key will adjust to "no"】**, and press  key to confirm the data resetting.







#### 7. Copy original parameter and resetting original parameter.

Under normal sewing mode, long press  key enter parameter interface, whole machine parameter finish setting, enter parameter no. P131, appear "0", press  key exchange to "1", and press  key for confirm, that's all for save original parameter.



Long press " "key enter parameter interface , enter parameter no. "P79", appear "0" , press "  "key exchange to "3", press " "key will appear "yes"【press "  "key will adjust to "no"】 , and press " " key for resetting original parameter.

### 8. Pattern design setting mode:

Under normal sewing mode , long press  key 2 seconds , the screen appear "d1" , press   key exchange to d1-d9 pattern, choose your pattern no. and press S for setting, the screen appear "1 3.0 01", now setting the stitching and gauge data for first stage, press left/right key to select setting data; after setting one stage, press left/right key move to left data, press +/- key move to other data setting, if current stitch is zero, can not go on next stage setting; After finish all the data of stitching and gauge, press  key for saving and return back to "d1" interface, press  key for exit and no save. Press  key return back to normal mode.

#### Remark:

- (1) The function is used for setting pattern design, could setting 9 kind of patterns, 16 teams each patterns; Under sewing mode, the pattern is as gauge.
- (2) Pattern sewing mode, if stopping during sewing, after press reverse button, the pattern sewing will be begin from zero. (fit for corner bend)

### III.System parameter table

NO	Project	Content	Setting range	The default value	level
P-01	Sewing speed	Set sewing speed	200~5000(rp m)	4100	1
P-02	Soft start function	Sewing few stitches at sewing start function 0: Invalid 1~9: Soft start stitches	0~9	2	1
P-04	Fixed-length seam sewing speed	Set fixed-length seam sewing speed	200~4000(rp m)	3000	1
P-06	Zero pitch correction value	When the needle pitch is set to 0mm, fine the value so that the actual sewing needle pitch is zero	50~150	100	2
P-07	Positive needle distance correction value	Magnification positive sewing distance (Sewing needle fixed distance)	50~150(%)	100	2
P-08	Anti-needle distance correction value	Enlarge reverse stitches Distance Scale (Sewing needle fixed distance)	50~150(%)	100	2
P-09	Back stitch speed limitation	can keep needle from breaking while backstitching	500~1500	800	1
P-10	Set the length of the stitch from the set number	0:Set the number of stitches to set the value 1:When the length is set to self-made, the number is the number of the pattern, that is, the total	0/1	1	1

		number of stitches is the number of stitches x set the value			
P-16	Output duty cycle of soft down	output duty cycle of soft down	0~100	8	2
P-17	Output duty cycle of trimmer and thread tension	Output duty cycle of trimmer and thread tension ( too small will affect trimmer and tension solenoid suction power )	0~100	50	2
P-18	The stitch pattern began after the termination of the stitch, mode selection	The stitch without pattern began after the termination of the stitch mode selection 0: unavailable 1: available	0/1	0	1
P-19	Solid after before sewing stop	0: unavailable 1: available	0/1	0	1
P-20	Attachment button select function mode	0: unavailable 1: Manual thread trimming in standby 2: Manual adjust presser foot after thread trimming	0/1/2	0	1
P-21	soft start speed 1	speed of the 1st needle of soft start	100~3000(rp m)	400	1
P-22	soft start speed 2	speed of the 2nd needle of soft start	100~3000(rp m)	1000	1
P-23	soft start speed 3	speed of the 3 rd~9th needle of soft start	100~3000(rp m)	1500	1
P-24	Presser foot soft lowering function	Setting to protect damaged the fabric to slow down the presser foot lowering speed	0/1	1	1
P-25	Presser foot lift function	Presser foot lift function set 0: unavailable 1: available 2:available after trimming	0/1/2	1	1
P-26	Function of over thickness	Setting the function of over thickness 0: unavailable 1: available	0/1	0	1
P-27	Power on and positioning	The function setting of automatically finding the needle position when the power is on 0: unavailable 1: available	0/1	0	1
P-28	Signal mode for turn/lift switch	Setting of signal mode of turn/lift switch of machine head 0: always open 1: always close 2:forbid a protection	0/1/2	0	1
P-29	Presser foot soft lowering time	To set presser foot soft lowering time The longer time the lower speed of the presser foot	10~500(ms)	150	2
P-30	Baseline count enable	0: unavailable 1: Auto count when cycle to the set value 2: Auto stop when count to set value	0/1/2	0	1
P-31	Baseline initial value setting	Baseline initial value setting	200~4000(0.1m)	1600	1
P-34	Standard joint speed mode selection	Select 0 automatic for standard joint speed mode; 1 pedal control	0/1	0	2
P-35	Multiple ratio of counting by piece	Setting of multiple ratio of counting by piece	0~50	0	1

P-36	Setting initial value of counting by piece	Setting initial value of counting by piece	0~1000	100	1
P-37	Time of thread wiper	Time of thread wiper	0~800(ms)	40	2
P-38	Setting function of choosing counting by piece	0: unavailable 1: Auto count when cycle increased to the set value 2: Auto count when cycle decreased to the set value 3: Auto stop when count increased to set value 4: Auto stop when count decreased to set value	0/1/2/3/4	0	1
P-41	Low speed	The lowest speed of pedal	100~500(rp m)	200	1
P-42	Pedal curve selection	Pedal speed adjustment 0: normal 1: Slow acceleration 2: Quick acceleration	0/1/2	2	1
P-44	Thread-cutting speed	thread-cutting speed	100~500(rp m)	250	1
P-45	Back-tracking speed limit function	Back-tracking speed processing can prevent reverse sewing needle breakage 0:no speed limit 1: infinite speed limit 2: the speed limit	0/1/2	0	1
P-46	Presser foot lifting delays sewing	delay with presser foot lowered	0~800(ms)	100	2
P-49	Press foot holding time	Lift the pressure foot after holding time to force off	1~60(s)	25	2
P-50	Output time of total pressure of presser foot lifting	output time of total pressure of presser foot lifting	0~800(ms)	150	2
P-51	Output duty cycle of presser foot lifting hold time of presser foot lifting	output duty cycle of presser foot lifting hold time of presser foot lifting	0~100	40	2
P-53	starting reinforcing-sewing speed	starting reinforcing-sewing speed	100~3000(rp m)	2200	1
P-56	ending reinforcing-sewing speed	ending reinforcing-sewing speed	100~3000(rp m)	2200	1
P-59	Continuous reinforcing-sewing speed	Continuous reinforcing-sewing speed	100~3000(rp m)	2200	1
P-60	Bartack stitch cancel speed limit	0: The software has speed limited 1: No speed limited (The stitch length may be unstable when stitch length is large and the speed is high)	0/1	0	2
P-61	A switch to cancel the angle limit when change stitch length	0: Change the stitch length within the limiting angle 1: change stitch length at any angle (The stitch length may not coincide, or the needle may break)	0/1	0	2

P-62	Pedal travel upon start	Pedal position upon start Travel relative to medium pedal	10~50(0.1°)	25	2
P-63	Pedal travel upon acceleration	Pedal position upon start acceleration Travel relative to medium pedal	10~100(0.1°)	50	2
P-64	Pedal travel at highest rotation speed	Pedal position at highest rotating speed Travel relative to medium pedal	10~150(0.1°)	110	2
P-65	Pedal travel upon presser foot lift	Pedal position upon pedal lift Travel relative to medium pedal	-100~-10(0.1°)	-25	2
P-67	Pedal travel 1 upon thread trimming	Pedal position upon start trimming without presser foot function Travel relative to medium pedal	-100~-10(0.1°)	-30	2
P-68	Pedal travel 2 upon thread trimming	Pedal position upon start thread trimming with presser foot function Travel relative to medium pedal	-100~-10(0.1°)	-50	2
P-69	Down needle positioning position	To adjust down needle position	0~240	160	1
P-70	Reverse needle lift function	Reversal of needle lift function after thread trimming 0: unavailable 1: available	0/1	0	1
P-71	Reversal of needle lift angle	Reversal of needle lift angle	0~45(°)	20	1
P-72	Thread clamp strength adjustment	Adjust the thread clamp strength size 0: Clip line function is invalid 1~9: Three Intensity Adjustment	0~9	6	1
P-73	Thread pressing actuation angle	Thread pressing actuation angle	10~150(°)	100	1
P-74	Thread pressing release angle	Thread pressing release angle	160~300(°)	270	1
P-75	Needle position adjustment	Needle position adjustment	0~240	33	1
P-77	Setting of beauty sewing	0: unavailable 1: available	0/1	0	1
P-78	Beauty sewing (close sewing) mode setting	1: Close stitch on start sewing 2: Close stitch on end-sewing 3: Close stitch on both start and end sewing	1/2/3	2	2
P-79	return to factory-set parameter	Special functional parameters 3: Return set parameters 5/8: Restore factory parameter	0~15	0	1
P-80	highest speed of sewing	highest speed of sewing	300~5000(rpm)	4100	2
P-81	Pedal speed percentage	Pedal speed percentage	50~100	100	2
P-82	Trial use function	Trial use function 0: Trial use function 10~1000: Trial use time	0~1000(h)	0	3
P-83	Strength function	Try if the needle can't penetrate the cloth. 0: invalid; 1~15: intensity adjustment	0~15	0	2
P-84	Function of cutting	Effective when the cutting wire is an	0~15	0	2

	line and adding force	electromagnet; 0: invalid; 1~15: intensity adjustment			
P-85	Cutting line suction Angle	Cutting line suction Angle set	150~200	174	3
P-86	Cutting line adding force Angle	Cutting line adding force Angle set	200~300	260	3
P-87	Cutting line release Angle	Cutting line release Angle set	300~360	340	3
P-88	Loose line suction Angle	Loose line suction Angle	0~360	180	2
P-89	Loose line release Angle	Loose line release Angle	0~360	350	2
P-90	Language selection setting	Setting of language: 0: turn off 1: Chinese 2: English	0~2	1	2
P-91	Change pitch selection	Change pitch selection 0:Changes Allowed 1:Not allowed to change	0~1	0	2
P-92	Pedal presser foot lift confirm time	Pedal presser foot lift confirm time	10~300(ms)	80	2
P-93	Pedal presser foot lift confirm time	Trimming the neutral position of the pedal	-15~15(0.1°)	0	2
P-94	Auto test mode set	Auto test mode set 0: standard time mode 1: stitch mode (Use P98 set stitch) 2: simple time mode 3: Factory aging mode (Do not use this mode in machine)	0~3	3	3
P-95	Anti-nest function selection	Anti-nest function selection: 0: thread clamp type 1: Anti-nest type 2: thread wiper type	0/1/2	0	2
P-96	Auto test maximum speed	Auto test maximum speed set	200~5000(rpm)	3500	3
P-97	Auto test stop time	Auto test stop time set	1~250 (0.1s)	20	3
P-98	Auto test running time/stitches	Auto test running time/stitches set	1~250(0.1s/stitch)	30	3
P-104	Pattern stop function enable	0: unavailable 1: Stop the needle need to go through the current number of pattern stitches	0/1	0	2
P-107	Overthickness detection sensitivity setting	Presser foot height sensor's coltage setting of overthickness detection Unit:mv) (Relative to the zero position voltage)	0~500	100	2
P-109	Force adjustment of electromagnet for presser foot lifting	Force adjustment of electromagnet for presser foot lifting (Cushion when press foot is absorbed)	50~100	80	2
P-110	Material thickness and tension control	Increase tension when sewing thick material	0~10	0	2
P-111	Overthickness sewing speed	Limit speed of overthickness	500~3000(rpm)	1500	2
P-112	Overthickness stitch	Overthickness stitch offset deals	50~150(%)	120	2

	offset coefficient				
P-113	Needle compensate stitch length mode	Needle compensate stitch length mode 0: normal stitch length 1: Needle compensate stitch length (press 114 to set) 2: reverse sewing by normal stitch length 3: reverse sewing by needle compensate stitch length	0~3	0	1
P-114	Needle compensate stitch length setting	Needle compensate stitch length setting	10~50 (70) mm	35	1
P-115	Back latch sewing button function setting	0: back latch sewing 1: tightly sewing 2: fill needle 3:back latch sewing+ fill needle 4: tightly sewing+ fill needle 5: Manual sewing (heavy duty) 6: Switch	0~7	0	2
P-116	fill needle button function setting	0: back latch sewing 1: tightly sewing 2: fill needle 3: back latch sewing+ fill needle 4: tightly sewing+ fill needle 5: Manual sewing (heavy duty)	0~5	2	2
P-117	Dense needle pitch setting	Head button stitch set	50~150	110	2
P-118	tightly sewing No function	tightly sewing setting	1~10	2	2
P-119	tightly sewing needle gauge setting	needle gauge setting	50~150	105	2
P-125	Stop and trimming during fixed-length sewing	0: invalid 1: valid	0/1	0	2
P-126	loose thread enable when start sewing	0: invalid 1: valid	0/1	1	2
P-127	Delay before start-sewing loose thread	Delay before start-sewing loose thread	0~1000	100	2
P-128	Action time of loose thread when start-sewing	Action time of loose thread when start-sewing	0~1000	660	2
P-129	Display backlight brightness Setting	Display backlight brightness Setting	0~10	5	1
P-130	Voice choice	0: invalid 1: valid	0~1	1	1
P-131	Factory parameter save selection	0. Invalid 1. Save the current values of all parameters	0~1	0	3
P-133	Fill needle mode option	0: Intermediate stop and thread trimming stop 1: Only intermediate stop	0~1	1	1
P-135	Midway back latch function selection	0: invalid 1: valid	0~1	0	1
P-136	The number of midway stitch set	1~50 needle	1~50	4	1

P-137	Setting the number of Mid-back latch stitching	1~10 times	1~10	1	1
P-138	Lock screen function setting	0: invalid 1: valid	0~1	1	1
P-139	Lock screen time setting	30~240 (s)	0~1	30	1
P-140	Anti-bird's nest delay before hooking	The delay time between the end of trimming and the hook	0~500ms	30	2
P-141	Anti-bird's nest Hook time	Wire hooking solenoid time	0~500ms	80	2
P-142	Anti-bird's nest delay after hooking	The delay time of hooking solenoid off	0~500ms	50	2
P-143	Anti-bird's nest Hook line duty cycle	Adjust the strength of the hooking solenoid	0~100	100	2
P-144	Anti-bird's nest Suction action time	Working time of suction valve	0~2000ms	350	2
P-145	Thread-straight work time of Anti-nest	The work time of a thread-straight solenoid	0~500ms	50	2
P-146	Anti-bird's nest Suction start angle	start angle during thread trimming	150~360	154	2
P-150	Maximum needle gauge setting	needle gauge of 5mm stitch length (1.0mm~5.0mm) needle gauge of 7mm stitch length model (1.0mm~7.0mm)	10~50 (70) mm	50	2
P-151	First off-line prevented stitch length	0: invalid 1: valid	0~1	0	2
P-152	First off-line prevented stitch length setting	Stitch length setting Parameter range (1.0mm~5.0mm)	10~50	40	2
P-153	Head button inching mode setting	0: Invalid 1: valid (Press once valid ,press again cancel, such as close sewing, over thickness, presser foot)	0~1	0	2
P-154	Back stitch button type	0: Ordinary switch 1: Travel switch	0~1	0	3
P-155	LED light setting	0: LED light light off 1~5: Adjust the brightness (HMI control 0/1/2/3/4/5/0switch)	0~5	5	2
P-156	Refueling reminder time setting	0: invalid 15~3000: Power-on trial time	0~3000	0	3
P-161	1/2 Fill needle button setting	0: Back latch sewing 1: tight sewing 2: 1/2 fill needle	0~2	2	2
P-170	Speed adjust coefficient	=0, P171~P176 are invalid =1, P171~P176 are valid	0~1	1	2
P-171	Speed forward sewing adjust	Speed forward sewing adjust	50~150	100	2

P-172	Speed backstitch adjust	Speed backstitch adjust	50~150	100	2
P-173	Front fixed sewing speed, forward sewing adjust	Front fixed sewing speed, forward sewing adjust	50~150	100	2
P-174	Front fixed sewing speed, back latch sewing adjust	Front fixed sewing speed, back latch sewing adjust	50~150	100	2
P-175	Rear fixed sewing speed, forward sewing adjust	Rear fixed sewing speed, forward sewing adjust	50~150	100	2
P-176	Rear fixed sewing speed, back latch sewing adjust	Rear fixed sewing speed, back latch sewing adjust	50~150	100	2
P-180	Needle gauge adjust coefficient	=0, P181~P200 valid =1, P181~P200 invalid	0~1	1	2
P-181	1mm regular sewing adjustment	1mm regular sewing adjustment	50~150	100	2
P-182	1mm Back latch sewing adjustment	1mm Back latch sewing adjustment	50~150	100	2
P-183	2mm regular sewing adjustment	2mm regular sewing adjustment	50~150	100	2
P-184	2mm Back latch sewing adjustment	2mm Back latch sewing adjustment	50~150	100	2
P-185	3mm regular sewing adjustment	3mm regular sewing adjustment	50~150	100	2
P-186	3mm Back latch sewing adjustment	3mm Back latch sewing adjustment	50~150	100	2
P-187	4mm regular sewing adjustment	4mm regular sewing adjustment	50~150	100	2
P-188	4mm Back latch sewing adjustment	4mm Back latch sewing adjustment	50~150	100	2
P-189	5mm regular sewing adjustment	5mm regular sewing adjustment	50~150	100	2
P-190	5mm Back latch sewing adjustment	5mm Back latch sewing adjustment	50~150	100	2
P-191	6mm regular sewing adjustment	6mm regular sewing adjustment	50~150	100	2
P-192	6mm Back latch sewing adjustment	6mm Back latch sewing adjustment	50~150	100	2
P193	7mm regular sewing adjustment	7mm regular sewing adjustment	50~150	100	2
P194	7mm Back latch sewing adjustment	7mm Back latch sewing adjustment	50~150	100	2
P195	8mm regular sewing adjustment	8mm regular sewing adjustment	50~150	100	2
P196	8mm Back latch	8mm Back latch sewing adjustment	50~150	100	2



	sewing adjustment			
--	-------------------	--	--	--

#### 4. Error code

Error Code	Contents	Possible reasons	Checking and treatment
E011 E012	Motor signal error	Motor position sensor signal failure	If electric engine plug is well contacted; if electric engine signal detecting device has been broken; if sewing machine handwheel correctly installed.
E021 E023	Motor overload	motor stall motor overload	If electric engine plug is well contacted; if machine head or thread-cutting mechanism has been blocked completely; f materials are too thick; Electrical signal detection signal whether the normal.

E101 Hardware dri06(dr)8.4(i06(dr)8.4(i06(6 v5m7 71s1)7.6( H)5.6T)7.6( H)5( ))T0(motor)7.9( ov)1i94(

E602	Hardware drivers fault	Feed motor STEP2 software overcurrent	Current detection loop system is working properly;Whether the damage to the device driver
E603	Hardware drivers fault	Feed motor STEP2 Current detection circuit	Current detection loop system is working properly;Whether the damage to the device driver.
E604	Motor signal error	Feed motor STEP2 The initial mechanical angle	Feed motor connector is a good contact
E605	Motor signal error	Feed motor STEP2 at the start, Encoder or rotor stuck	Feed motor connector is a good contact Machinery is stuck
E606	Hardware drivers fault	Feed motor STEP2 Motor winding circuit	Current detection loop system is working properly; Wether the damage to the device driver.
P.oFF	Power off Display	Power off	Wait for power supply to resume.
EvAL	Trial expired	Trial expired	Contact the dealer processing
L.bob	The bottom line tips	The bottom line count value is negative	After replacing the bottom line, press P to cancel the Alert Status
P.bob	Remind of counting by piece	The number of counting is 0	Press S key to enter the interface, and long press "front seam" button for more than 2 seconds to cancel the prompt state

## 6. Definition of Socket

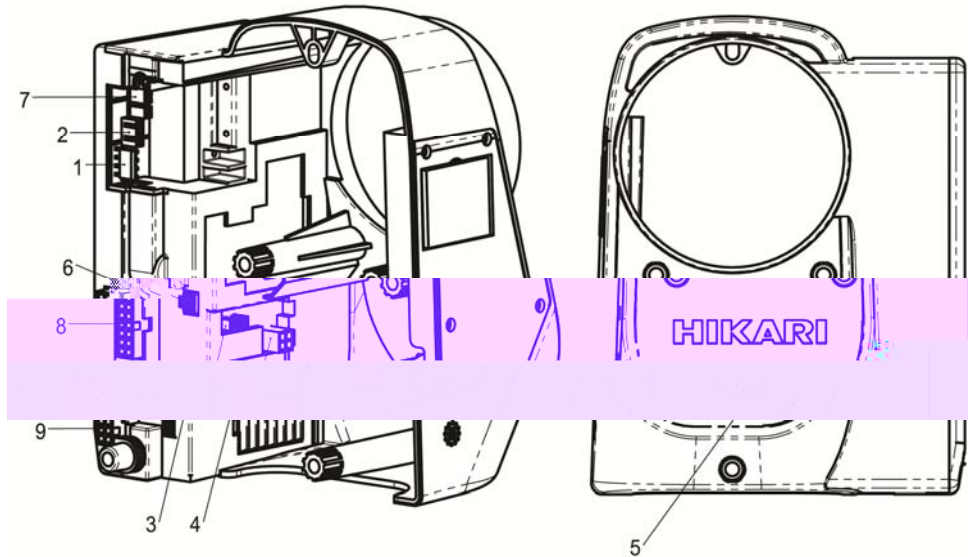

### 1. Servo motor power socket (number of board position:CN1)

Pin	Definition	Pin	Definition
1PIN	Phase C	3PIN	Phase A
2PIN	Phase B	4PIN	EARTH



### 2. Servo motor encoder interface (number of board position:CN7)

Pin	Definition	Pin	Definition
1PIN	UP	4PIN	5V-2
2PIN	PGND	5PIN	ENCA
3PIN	ENCB		

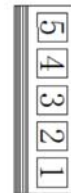

### 3. Interface of Feeding stepper motor encoder (CN9)

Pin	Definition	Pin	Definition
1PIN	PHZ_STEP (zero position )	4PIN	PHA_STEP (A)
2PIN	PHB_STEP (B)	5PIN	5V-2 (Power Supply)
3PIN	PGND (Earth)		



### 4. Interface of feeding stepper motor power (J1)

Pin	Definition	Pin	Definition
1PIN	A+	3PIN	B+
2PIN	A-	4PIN	B-

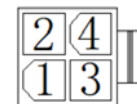

### 5. USB charging socket (CN16)

Pin	Definition	Pin	Definition
1PIN	5V-1	2PIN	GND



### 6. Interface of serial communication (CN10)

Pin	Definition	Pin	Definition
1PIN	5V-1 (Power supply)	3PIN	TX (Single )
2PIN	RX (Single )	4PIN	GND (Earth)



## 7. Interface of operation box interface (CN11)

Pin	Definition	Pin	Definition
1PIN	RX (Single)	4PIN	GND (Earth)
2PIN	TX (Single)	5PIN	RX_1 Flash Loader
3PIN	5V-1 (Power supply)	6PIN	TX_1 Flash Loader



## 8. Interface of solenoid and needle bar light (number of board position: CN8)

Pin	Definition	Pin	Definition
1PIN	VDD_DCT(Voltage solenoid)	8PIN	JX_DCT (Trimming solenoid)
2PIN	VDD_DCT(Voltage solenoid)	9PIN	BX_DCT (Wiring and clamping solenoid)
3PIN	VDD_DCT(Voltage solenoid)	10PIN	SX_DCT (Loose wire solenoid)
4PIN	GND	11PIN	5V-1 (Light of needle bar)
5PIN	Reverse stitching signal	12PIN	LAMP Brightness debug signal
6PIN	VDD_DCT(Voltage)	13PIN	TYJ_DCT (Foot pressure solenoid )
7PIN	Needle compensation signal	14PIN	1/2 Needle compensation (BZKG)

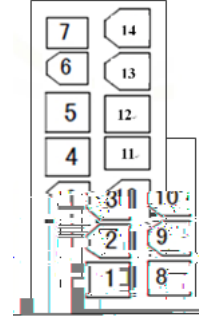

## 9. Interface of pedal (number of board position: CN3)

Pin	Definition	Pin	Definition
1PIN	5V-2(Power supply)	4PIN	Machine manufacture Factory using
2PIN	PGND(Earth)	5PIN	Machine manufacture Factory using
3PIN	PEDAL(Pedal signal)	6PIN	Machine manufacture Factory us

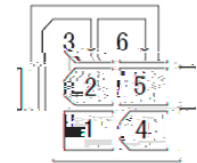

## 10. Interface of anti-bird's nest solenoid (number of board position: CN15)

Pin	Definition	Pin	Definition
1PIN	VDD_DCT(Voltage solenoid)	4PIN	TX_DCT (Fixing wire solenoid)
2PIN	VDD_DCT(Voltage solenoid)	5PIN	GX_DCT Hooking wire solenoid
3PIN	VDD_DCT(Voltage solenoid)	6PIN	XF_DCT(Suction solenoid valve)

